

MaxMotion

PERFORMANCE DATA SHEET

Meets or exceeds MEPS (Minimum Efficiency Performance Standards), as described by the US Department of Energy in docket 10CFR431 and Natural Resources Canada's Amendment 14

Catalogue #: **MPRP-204JH**

HP	kW	Voltage	S.F. @ 60Hz	Efficiency	Power Factor	Frame	Design	L.R. Amps
2	1,49	575	1,15	87,6%	0,800	56HJ	B	30

60 Hz								
FLA							Code	F.L. RPM
208	230	416	460	480	575	600		
/	/	/	/	/	2,15	/	L	1752

50 Hz								
HP	kW	FLA		S.F. @ 50Hz	Efficiency	Power Factor	Code	F.L. RPM
		190	380					
/	-	/	/	/	/	/	/	/

Wgt. Lbs	PH	Duty	Insul. Class	Amb.	Elevation	Temp. Rise° C
37	3	Cont.	F	40°C	1000M (3300 Ft)	31

% Efficiency		% Power Factor		Torque		Winding Resist. Ω	Safe Cold Start (Secs)
Full Load:	87,6%	Full Load:	0,80	Full Load Ft/Lbs	6,0		
3/4 Load:	88,1%	3/4 Load:	0,72	Locked Rotor %	321		
1/2 Load:	86,9%	1/2 Load:	0,58	Break Down %	394	11,42	12

Rotor Inertia Wk2 Lb-Ft2	Max Load Inertia Wk2 Lb-Ft2	Shaft Material	Frame Material	DE Bracket Type	ODE Bracket Type	Enclosure	NEMA Rating	Lead Wire Size
/	/	304SS	Rolled Steel	Aluminium Alloy		TEFC	IP55	14AWG

Ball Bearings		Grease	Mount Type	Orientation	Paint	Sound Pressure @ 3FT	Sound Power
DE	ODE						
6205	6203	Sealed Bearings	Rigid	Horizontal	Black	67	/

Inverter Duty.	Constant Torque Range	Variable Torque Range	Constant HP RPM
Motor meets MG1 parts 31.4.4.2	10:1	20:1	2700

WIRING CONNECTION DIAGRAM : D

56C, Single Voltage, DOL, 3 Leads WYE Connection
575 VAC 3 phase

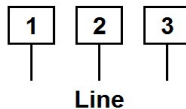

Date: 2024-05-01
 Customer: _____
 Contact: _____
 Submittee: J.C. Lavallée

Catalogue #: **MPRP-204JH**

Meets or exceeds MEPS (Minimum Efficiency Performance Standards), as described by the US Department of Energy in docket 10CFR431 and Natural Resources Canada's Amendment 14

HP	VAC	RPM	Enclosure	Frame	Frequency	Design	Poles	LR Code Letter	Insulation Class	Temp. Rise °C
2	575	1752	TEFC	56HJ	60	B	4	L	F	31

	0Hz	6Hz	15Hz	30Hz	45Hz	60Hz	75Hz	90Hz	105Hz	120Hz
Amps	2,15	2,15	2,15	2,15	2,15	2,15	2,15	2,15	2,15	2,15
RPM	0	175,2	438	876	1314	1752	2190	2628	3066	3504
Torq ft.lb	4,80	4,80	6,00	6,00	6,00	6,00	4,80	4,00	3,43	3,00
Peak Tq ft.lb	8,90	17,81	17,81	17,81	17,81	17,81	14,25	11,87	10,18	8,90
HP	0	0,2	0,5	1,0	1,5	2,0	2,0	2,0	2,0	2,0

	Locked Rotor	Pull-Up	Breakdown	Rated Load	Idle	Duty	S. F.	Ambient	Elevation	dBA @ 1M
Speed (RPM)	0,0	756	1440	1752	1800	Continuous	1,15	40°C	3,300 ft	67
Current (Amps)	30,0	25,5	17,9	2,2	1,2	VFD Rating: Meets MG1 parts 31.4.4.2				
Torque (ft-lbs)	19,2	16,4	23,6	6,0	0,0	C.T.	10:1	V.T.	20:1	

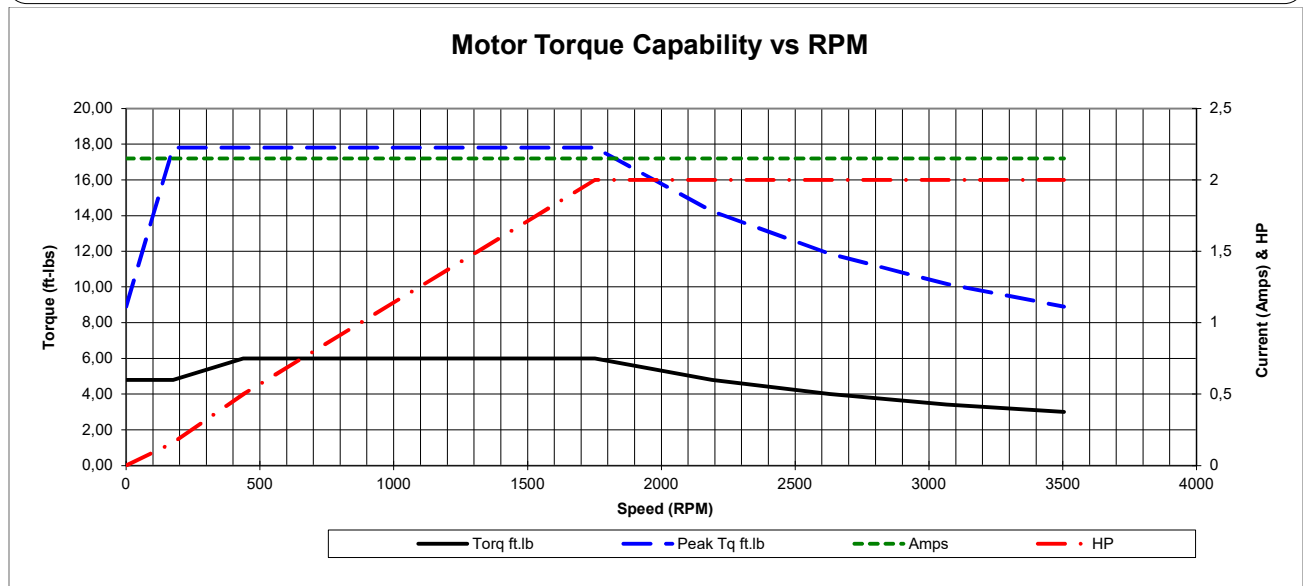
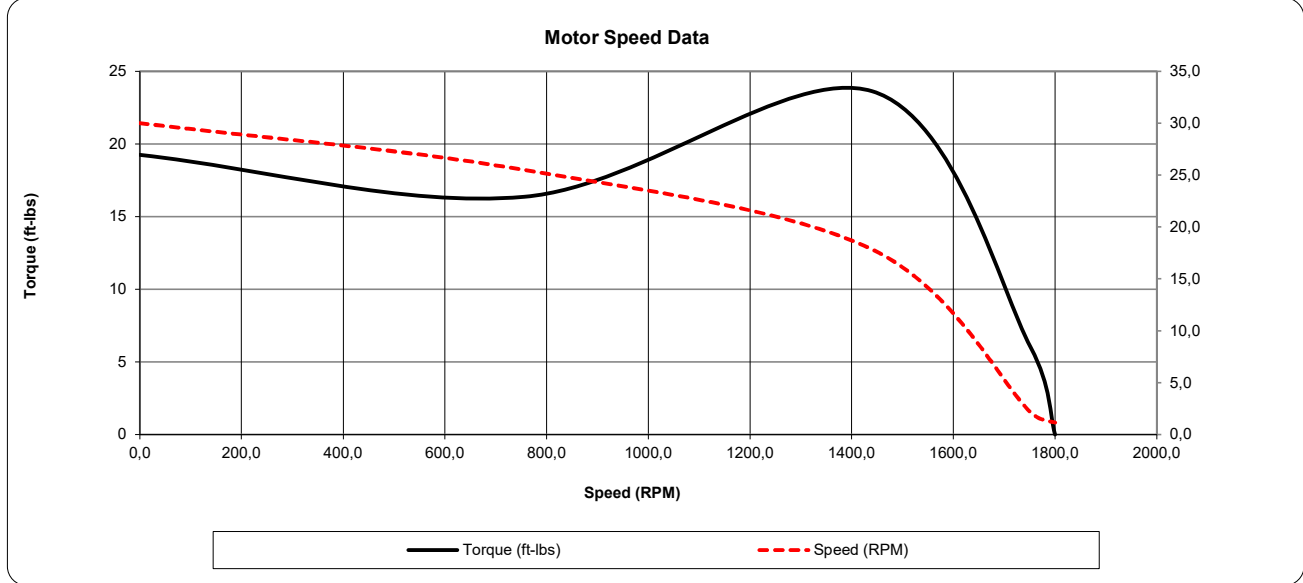



Date: 2024-05-01
 Customer: _____
 Contact: _____
 Submittee: J.C. Lavallée

Catalogue #: **MPRP-204JH**

Meets or exceeds MEPS (Minimum Efficiency Performance Standards), as described by the US Department of Energy in docket 10CFR431 and Natural Resources Canada's Amendment 14

HP	VAC	RPM	Enclosure	Frame	Frequency	Design	Poles	LR Code Letter	Insulation Class	Temp. Rise °C
2	575	1752	TEFC	56HJ	60	B	4	L	F	31

Load %	0%	25%	50%	75%	100%	125%	150%
Amps	1,17	1,24	1,43	1,72	2,15	2,69	3,23
Torq ft/lbs	0	1,47	2,96	4,47	6,00	7,55	9,12
RPM	0	1788	1776	1764	1752	1740	1728
Eff	0	80,00	86,90	88,10	87,60	85,39	82,95
PF	0	35,0	58	72	80,0	81,6	84,0

	Locked Rotor	Pull-Up	Breakdown	Rated Load	Idle	Duty	S. F.	Ambient	Elevation	dBA @ 1M
Speed (RPM)	0	756	1440	1752	1800	Continuous	1,15	40°C	3,300 ft	67
Current (Amps)	30	25,5	17,9	2,15	1,171	VFD Rating: Meets MG1 parts 31.4.4.2				
Torque (ft-lbs)	19,25	16,36	23,62	6,00	0,0	C.T.	10:1	V.T.	20:1	

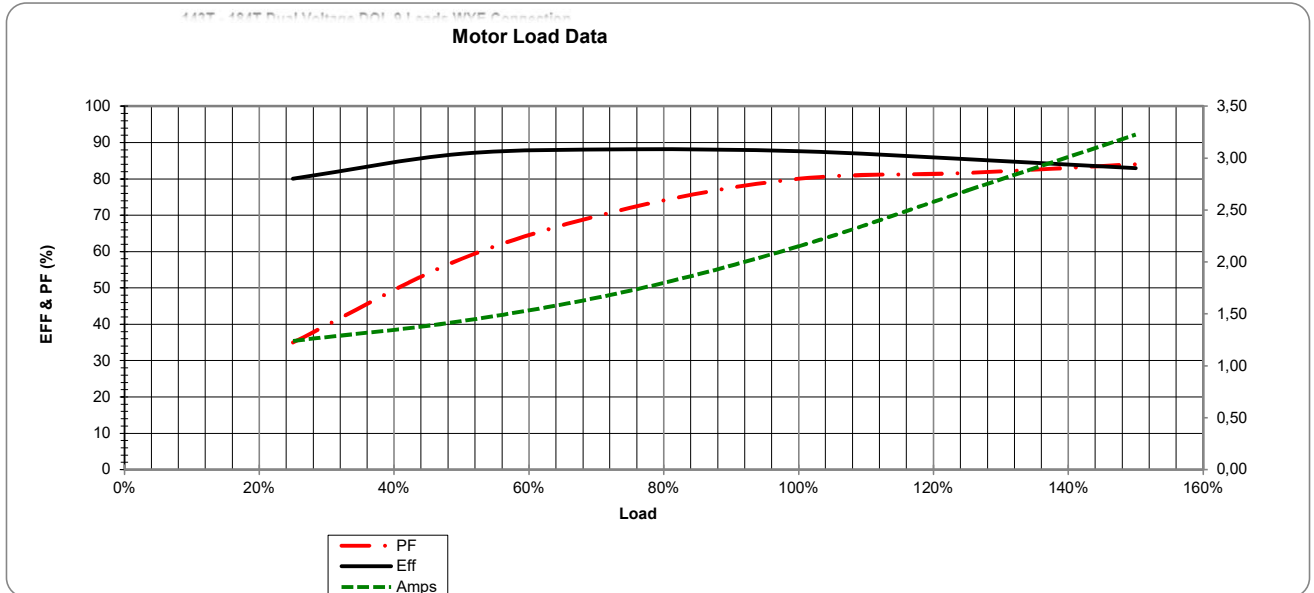
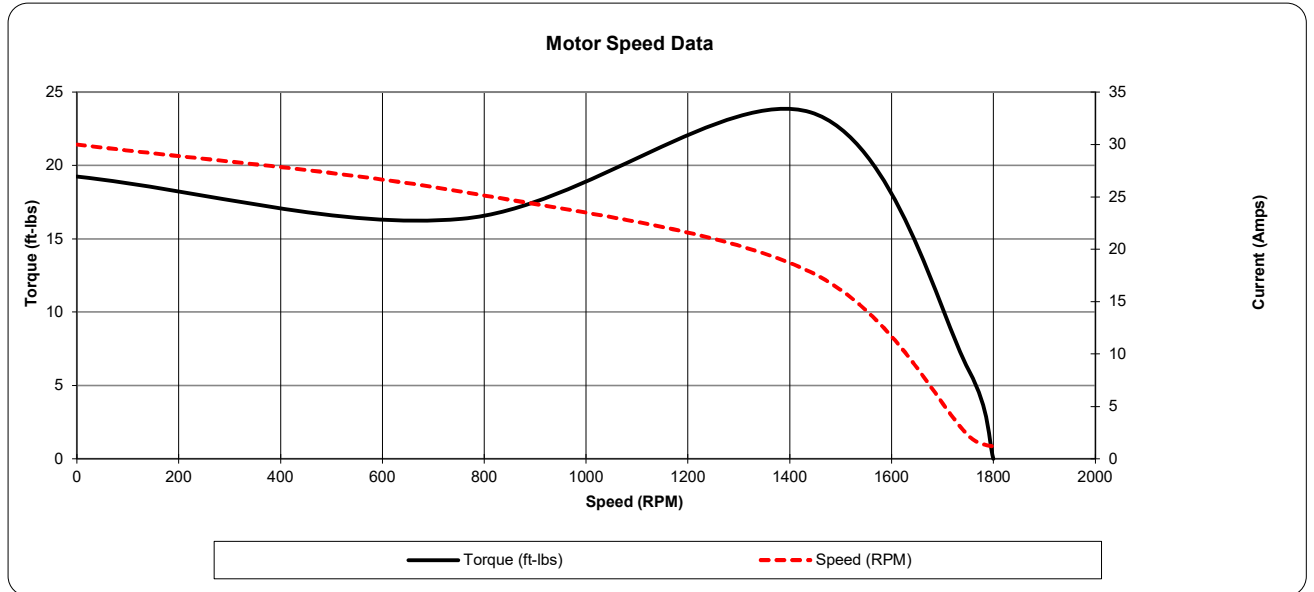

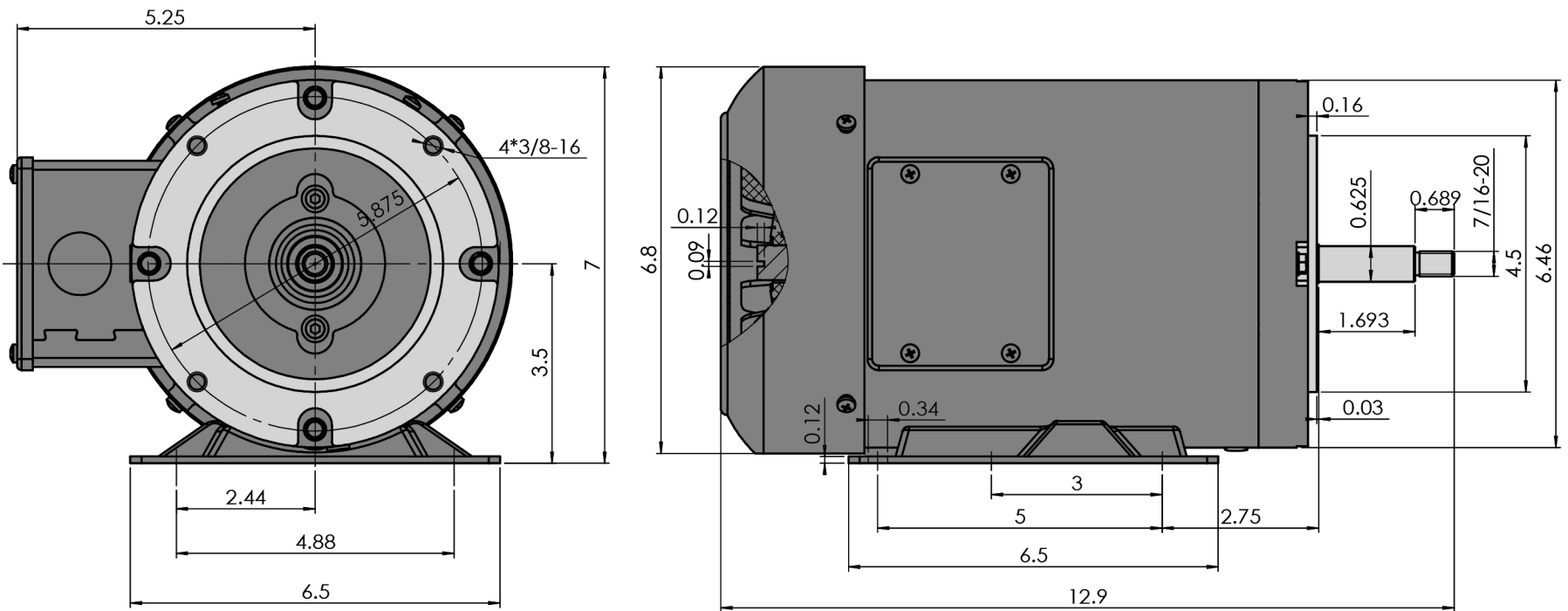

Version:1HUA	Revised: January 2023	HP	RPM	FRAME	ENCLOSURE	MQRP/MPRP-204JH
Customer is responsible in determining that MaxMotion product will fit/perform suitably in the intended application		2	1800	56J	TEFC	

JET PUMP 56J 3 PHASE AC MOTORS

HEAVY GAUGE ROLLED STEEL CONSTRUCTION

TEFC TOTALLY ENCLOSED FAN COOLED



Applications:

Jet pump motors are designed for industrial and commercial applications in mind. Motors are designed with removable feet, allowing easy replacement of footless flange mounted motors or rigid base 56J TEFC motors mounting. Motor construction is suitable for processing, water treatment, and circulatory pumps. Typical industries where applicable, cement, chemical, food processing, agriculture & pulp & paper.

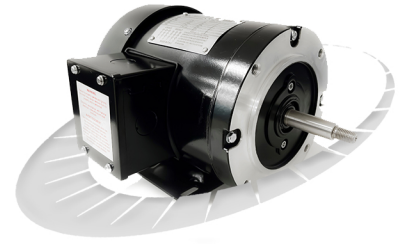

Features:

Design - NEMA Standard MG-1, design B, ambient temperature of 40°C, altitude 1000M, temperature rise B.

Agency Listings and Standard - NEMA MG1, IEEE, IEC, DOE registered, NRCAN, CSAUS and CSA Certified, CE and RoHS Compliant

Service Factor - 1.15

Electrical Supply - 3 phase, 230/460VAC, 575VAC @ 60 hz, 3 phase 190/380VAC @ 50 Hz rated to the next lower HP. ($\pm 10\%$ Voltage tolerance)

Windings - Highest quality Corona resistant, Inverter duty copper wire. VPI impregnated with additional dip and bake.

Efficiency - Integral HP models meet or exceed NEMA Premium efficiency levels.

Insulation - Class F insulation, with non-hygroscopic motor leads.

Bearings - Permanently Lubricated High quality Double Shielded Ball Bearings with oversized DE bearings. Lithium based grease operating temperature range – 25° through 175°C.

Enclosure Protection - Totally Enclosed Fan Cooled meeting IEC standard IP55. Factory Certified Division 2 Class I Groups A, B, C, D Class 11 Groups F, G. Meets Temp Code T2B.

Frame Construction - Rolled Steel with cast aluminum end shields.

Conduit Box - With ½ NPT knockouts positioned for wiring access every 90° with rubber gasket between box and motor frame.

Inverter Duty - Constant torque: 10/1 ratio, variable torque: 20/1 ratio

Nameplate - Stainless steel with etched details.

Drain Hole - Positioned in the stator frame at the lowest point, when motors are horizontally mounted.

Fan cover - Plastic fan & heavy duty plastic fan guard

Warranty - 1 year



JET PUMP 56J 3 PHASE AC MOTORS

HEAVY GAUGE ROLLED STEEL CONSTRUCTION

TEFC TOTALLY ENCLOSED FAN COOLED



HP	FL RPM	VOLTS	FRAME	CAT NO.	CONSTRUCTION	NOM EFF.	F.L. AMPS	CODE	WT (Lbs)	DE BRG	ODE BRG	"C" Dimension (Inch)
0,33	3481	208-230/460	56J	MQR-132JH	Rolled Steel	67,6	1.28-1.31/0.66	L	21	6205	6203	11.1
	3470	575	56J	MPR-132JH	Rolled Steel	62,8	0,57	L	21	6205	6203	11.1
	1744	208-230/460	56J	MQR-134JH	Rolled Steel	66,1	1.53-1.63/0.82	L	22	6205	6203	11.1
	1750	575	56J	MPR-134JH	Rolled Steel	69,2	0,58	L	22	6205	6203	11.1
0,50	3466	208-230/460	56J	MQR-122JH	Rolled Steel	71,6	1.74-1.67/0.84	L	21	6205	6203	11.1
	3471	575	56J	MPR-122JH	Rolled Steel	69,3	0,672	L	21	6205	6203	11.1
	1741	208-230/460	56J	MQR-124JH	Rolled Steel	74,1	1.9-1.95/0.98	L	24	6205	6203	11.1
	1753	575	56J	MPR-124JH	Rolled Steel	77,1	0,71	L	24	6203	6203	11.1
0,75	3469	208-230/460	56J	MQR-342JH	Rolled Steel	80,3	2.24-2.08/1.04	L	22,5	6205	6203	11.1
	3474	575	56J	MPR-342JH	Rolled Steel	76,2	0,86	L	22,5	6205	6203	11.1
	1738	208-230/460	56J	MQR-344JH	Rolled Steel	80,7	2.43-2.34/1.18	L	25,3	6205	6203	11.1
	1744	575	56J	MPR-344JH	Rolled Steel	80,5	0,91	L	25,3	6205	6203	11.1
1	3506	208-230/460	56J	MQRP-102JH	Rolled Steel	82,7	2.92-2.75/1.38	L	25	6205	6203	11.1
	3510	575	56J	MPRP-102JH	Rolled Steel	80,7	1,14	L	25	6205	6203	11.1
	1752	208-230/460	56J	MQRP-104JH	Rolled Steel	86,5	3.01-2.82/1.41	L	27	6205	6203	11.1
	1756	575	56J	MPRP-104JH	Rolled Steel	85,6	1,14	L	27	6205	6203	11.1
1,5	3492	208-230/460	56J	MQRP-152JH	Rolled Steel	86,6	4.03-3.81/1.9	L	28	6205	6203	11.1
	3478	575	56J	MPRP-152JH	Rolled Steel	85,1	1,61	L	28	6205	6203	11.1
	1752	208-230/460	56J	MQRP-154JH	Rolled Steel	86,6	4.59-4.41/2.21	L	31	6205	6203	11.9
	1745	575	56J	MPRP-154JH	Rolled Steel	86,7	1,65	L	31	6205	6203	11.9
2	3500	208-230/460	56J	MQRP-202JH	Rolled Steel	85,5	5.39-5.05/2.53	L	32	6205	6203	11.9
	3502	575	56J	MPRP-202JH	Rolled Steel	86	2,03	L	32	6205	6203	11.9
	1741	208-230/460	56J	MQRP-204JH	Rolled Steel	87,1	6.0-5.43/2.74	L	37	6205	6203	12.9
	1752	575	56J	MPRP-204JH	Rolled Steel	87,6	2,15	L	37	6205	6203	12.9
3	3513	208-230/460	56J	MQRP-302JH	Rolled Steel	87,6	7.81-7.18/3.54	L	42	6205	6203	12.9
	3512	575	56J	MPRP-302JH	Rolled Steel	87,6	3,05	L	42	6205	6203	12.9

